

NPB-4548-L8C(D)
2.488Gbps SFP Bi-Directional Transceiver, 80km Reach
1490nm TX / 1550 nm RX

Features

Dual data-rate of 2.488Gbps/2.125Gbps operation
 1490nm DFB laser and PIN photo detector for 80km transmission
 Compliant with SFP MSA and SFF-8472 with duplex LC receptacle

Digital Diagnostic Monitoring:

Internal Calibration or External Calibration

Compatible with RoHS

+3.3V single power supply

Operating case temperature: Standard: 0 to +70°C Industrial: -40 to +85°C



Applications

SDH STM-16 and SONET OC-48 system

2X Fiber Channel

Switch to Switch interface

Switched backplane applications

Router/Server interface

Other optical transmission systems

Description

The SFP transceivers are high-performance, cost-effective modules supporting dual data-rate of 2.488Gbps/2.125Gbps and 80km transmission distance with SMF. The transceiver consists of three sections: a DFB laser transmitter, a PIN photodiode integrated with a trans-impedance preamplifier (TIA) and MCU control unit. All modules satisfy class I laser safety requirements. The transceivers are compatible with SFP Multi-Source Agreement (MSA) and SFF-8472. For further information, please refer to SFP MSA.

Module Block Diagram

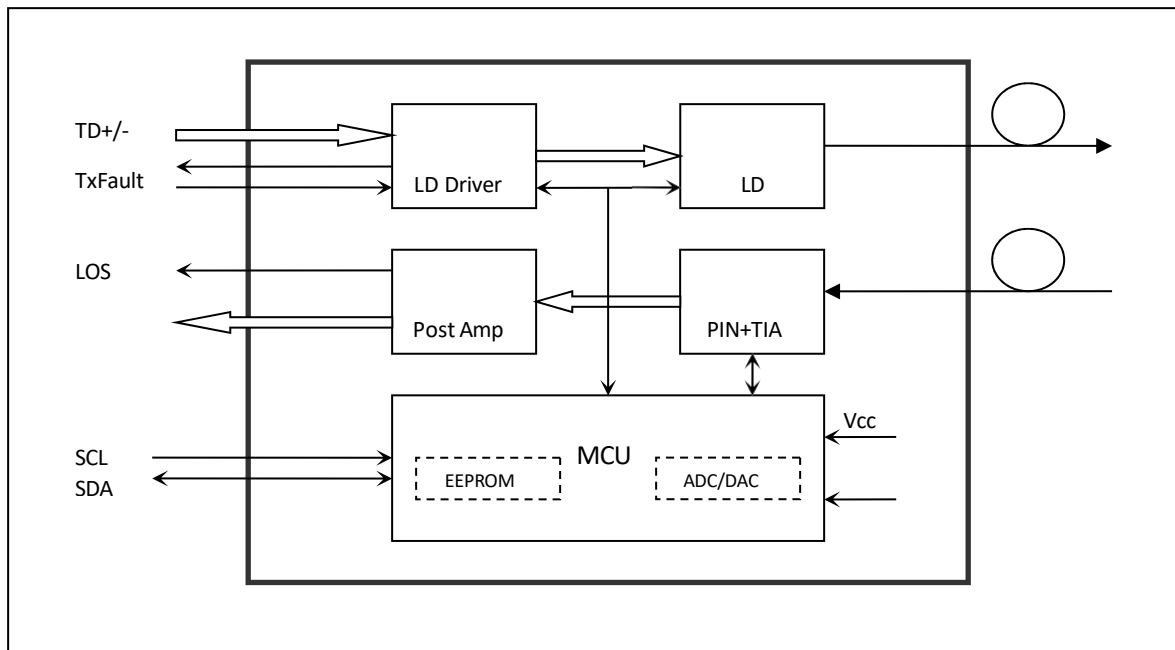

Absolute Maximum Ratings

Table 1 - Absolute Maximum Ratings

Parameter	Symbol	Min	Max	Unit
Supply Voltage	Vcc	-0.5	4.5	V
Storage Temperature	Ts	-40	+85	°C
Operating Humidity	-	5	85	%

Recommended Operating Conditions

Table 2 - Recommended Operating Conditions

Parameter	Symbol	Min	Typical	Max	Unit
Operating Case Temperature	Tc	0		+70	°C
Power Supply Voltage	Vcc	3.13	3.3	3.47	V
Power Supply Current	Icc			300	mA
Data Rate			2.67		Mbps

Optical and Electrical Characteristics

Table 3 - Optical and Electrical Characteristics

Parameter	Symbol	Min	Typical	Max	Unit	Notes
Transmitter						
Centre Wavelength	λ_c	1470	1490	1510	nm	
Spectral Width (-20dB)	$\Delta\lambda$			1	nm	
Side Mode Suppression Ratio	SMSR	30			dB	
Average Output Power	P _{out}	0		+5	dBm	1
Extinction Ratio	ER	9			dB	
Optical Rise/Fall Time (20%~80%)	t _r /t _f			0.16	ns	
Data Input Swing Differential	V _{IN}	400		1800	mV	2
Input Differential Impedance	Z _{IN}	90	100	110	Ω	
TX Disable	Disable	2.0		V _{cc}	V	
	Enable	0		0.8	V	
TX Fault	Fault	2.0		V _{cc}	V	
	Normal	0		0.8	V	
Receiver						
Centre Wavelength	λ_c	1530		1570	nm	
Receiver Power Low				-28	dBm	3
Receiver Power High		-9			dBm	3
Receiver Overload		-9			dBm	3
LOS De-Assert	LOS _D			-31	dBm	
LOS Assert	LOS _A	-35			dBm	
LOS Hysteresis		1		4	dB	
Data Output Swing Differential	V _{out}	400		1800	mV	4
LOS	High	2.0		V _{cc}	V	
	Low			0.8	V	

Notes:

1. The optical power is launched into SMF.
2. PECL input, internally AC-coupled and terminated.
3. Measured with a PRBS 2²³-1 test pattern @2488Mbps, BER ≤1×10⁻¹².
4. Internally AC-coupled.

Timing and Electrical

Table 4 - Timing and Electrical

Parameter	Symbol	Min	Typical	Max	Unit
Tx Disable Negate Time	t_on			1	ms
Tx Disable Assert Time	t_off			10	μs
Time To Initialize, including Reset of Tx Fault	t_init			300	ms
Tx Fault Assert Time	t_fault			100	μs
Tx Disable To Reset	t_reset	10			μs
LOS Assert Time	t_loss_on			100	μs
LOS De-assert Time	t_loss_off			100	μs
Serial ID Clock Rate	f_serial_clock			400	KHz
MOD_DEF (0:2)-High	VH	2		Vcc	V
MOD_DEF (0:2)-Low	VL			0.8	V

Diagnostics

Table 5 – Diagnostics Specification

Parameter	Range	Unit	Accuracy	Calibration
Temperature	0 to +70	°C	±3°C	Internal / External
Voltage	3.0 to 3.6	V	±3%	Internal / External
Bias Current	0 to 100	mA	±10%	Internal / External
TX Power	0 to 5	dBm	±3dB	Internal / External
RX Power	-28 to -9	dBm	±3dB	Internal / External

Digital Diagnostic Memory Map

The transceivers provide serial ID memory contents and diagnostic information about the present operating conditions by the 2-wire serial interface (SCL, SDA).

The diagnostic information with internal calibration or external calibration all are implemented, including received power monitoring, transmitted power monitoring, bias current monitoring, supply voltage monitoring and temperature monitoring.

The digital diagnostic memory map specific data field defines as following.

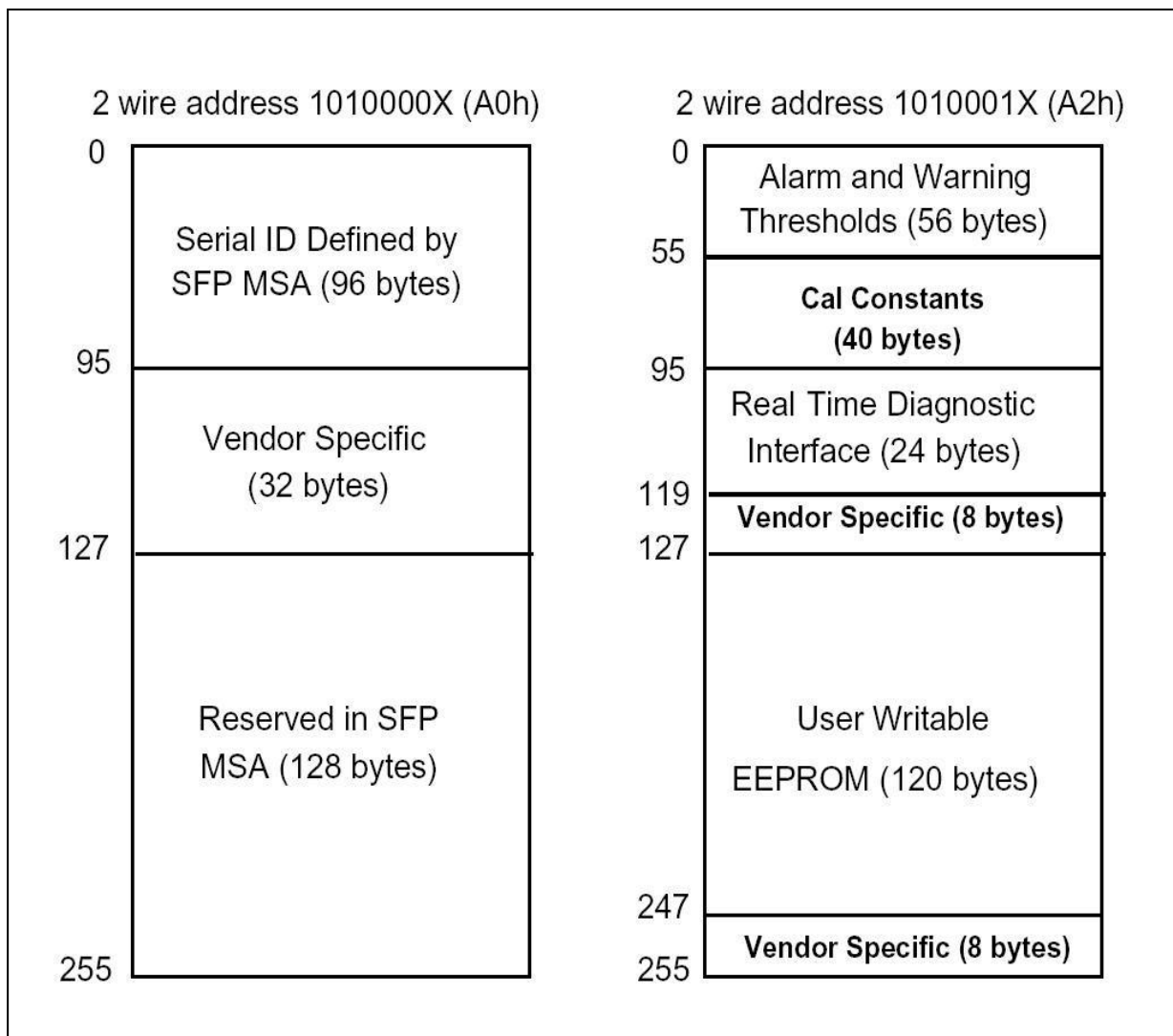

Pin Definitions

Pin Diagram

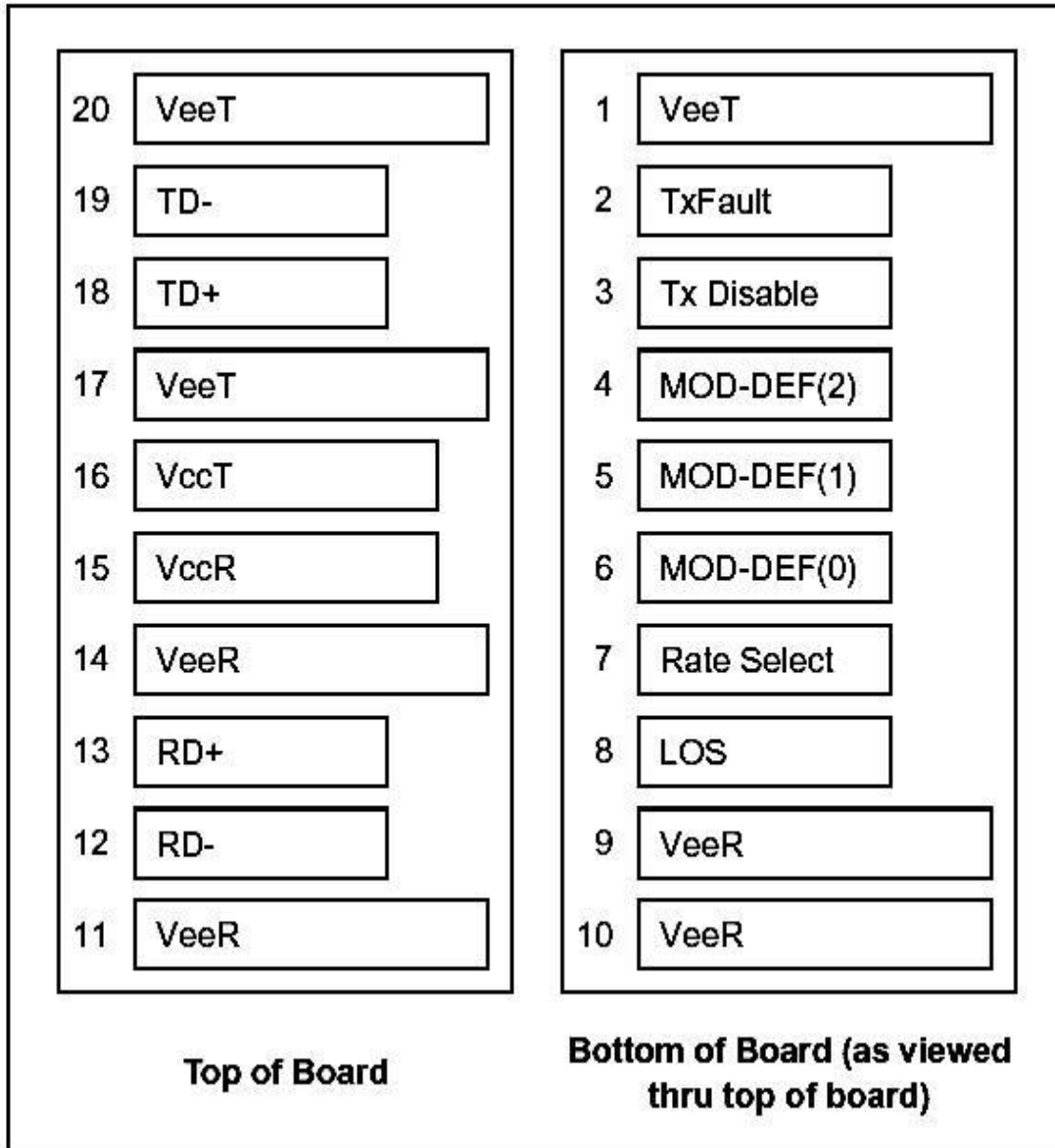

Pin Descriptions

Pin	Signal Name	Description	Plug Seq.	Notes
1	V _{EET}	Transmitter Ground	1	
2	TX FAULT	Transmitter Fault Indication	3	Note 1
3	TX DISABLE	Transmitter Disable	3	Note 2
4	MOD_DEF(2)	SDA Serial Data Signal	3	Note 3
5	MOD_DEF(1)	SCL Serial Clock Signal	3	Note 3
6	MOD_DEF(0)	TTL Low	3	Note 3
7	Rate Select	Not Connected	3	
8	LOS	Loss of Signal	3	Note 4
9	V _{EER}	Receiver ground	1	
10	V _{EER}	Receiver ground	1	
11	V _{EER}	Receiver ground	1	
12	RD-	Inv. Received Data Out	3	Note 5
13	RD+	Received Data Out	3	Note 5
14	V _{EER}	Receiver ground	1	
15	V _{CCR}	Receiver Power Supply	2	
16	V _{CCT}	Transmitter Power Supply	2	
17	V _{EET}	Transmitter Ground	1	
18	TD+	Transmit Data In	3	Note 6
19	TD-	Inv. Transmit Data In	3	Note 6
20	V _{EET}	Transmitter Ground	1	

Notes:

Plug Seq.: Pin engagement sequence during hot plugging.

- TX Fault is an open collector output, which should be pulled up with a 4.7k~10kΩ resistor on the host board to a voltage between 2.0V and V_{cc}+0.3V. Logic 0 indicates normal operation; Logic 1 indicates a laser fault of some kind. In the low state, the output will be pulled to less than 0.8V.
- TX Disable is an input that is used to shut down the transmitter optical output. It is pulled up within the module with a 4.7k~10kΩ resistor. Its states are:

Low (0 to 0.8V):	Transmitter on
(>0.8V, < 2.0V):	Undefined
High (2.0 to 3.465V):	Transmitter Disabled
Open:	Transmitter Disabled
- Mod-Def 0,1,2. These are the module definition pins. They should be pulled up with a 4.7k~10kΩ resistor on the host board. The pull-up voltage shall be V_{ccT} or V_{ccR}.
 Mod-Def 0 is grounded by the module to indicate that the module is present
 Mod-Def 1 is the clock line of two wire serial interface for serial ID
 Mod-Def 2 is the data line of two wire serial interface for serial ID
- LOS is an open collector output, which should be pulled up with a 4.7k~10kΩ resistor. Pull up voltage between 2.0V and V_{cc}+0.3V. Logic 1 indicates loss of signal; Logic 0 indicates normal operation. In the low state, the output will be pulled to less than 0.8V.
- RD-/+ : These are the differential receiver outputs. They are internally AC-coupled 100 differential lines which should be terminated with 100Ω (differential) at the user SERDES.
- TD-/+ : These are the differential transmitter inputs. They are internally AC-coupled, differential lines with 100Ω differential termination inside the module.

Recommended Interface Circuit

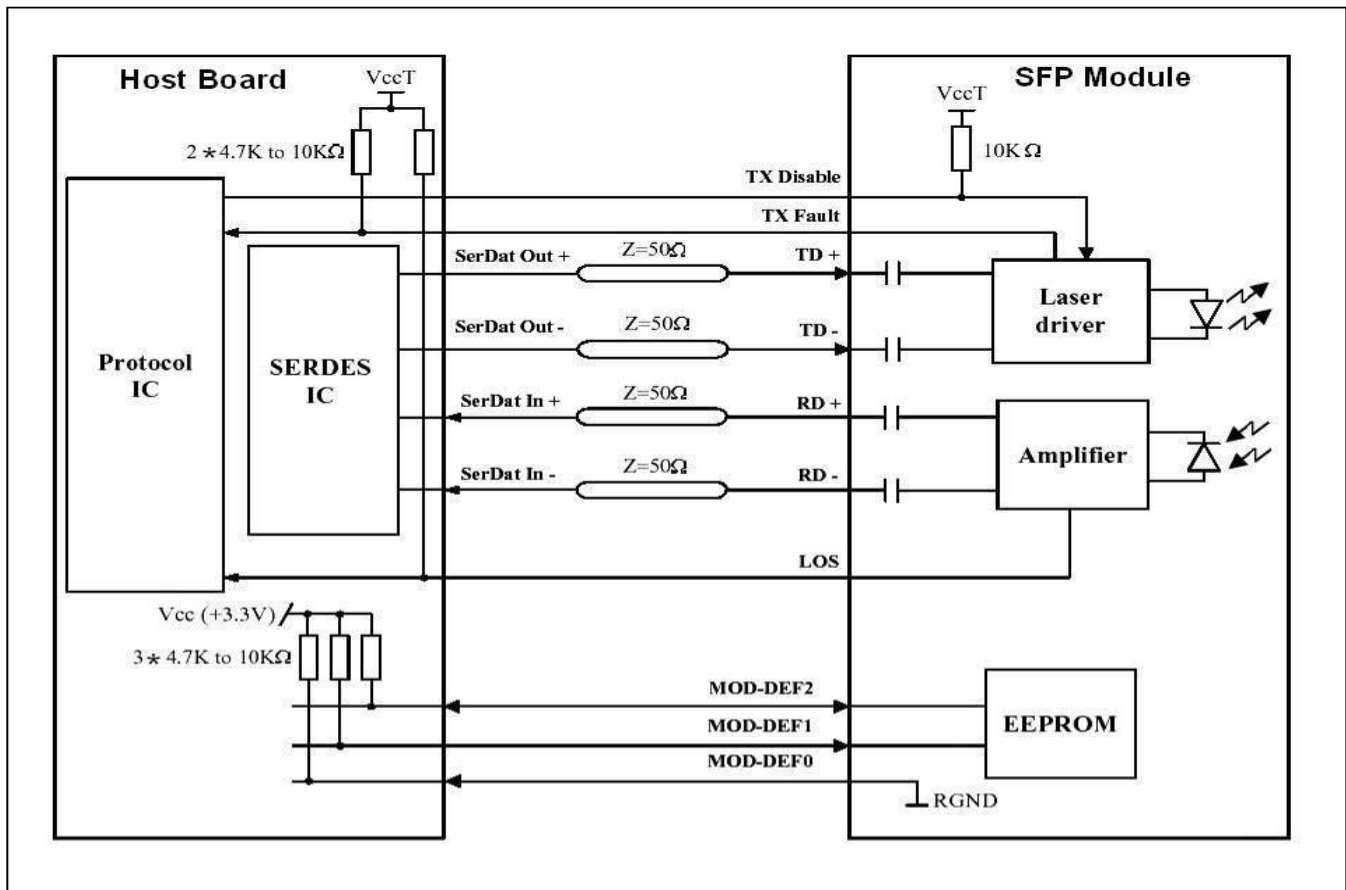

Mechanical Dimensions

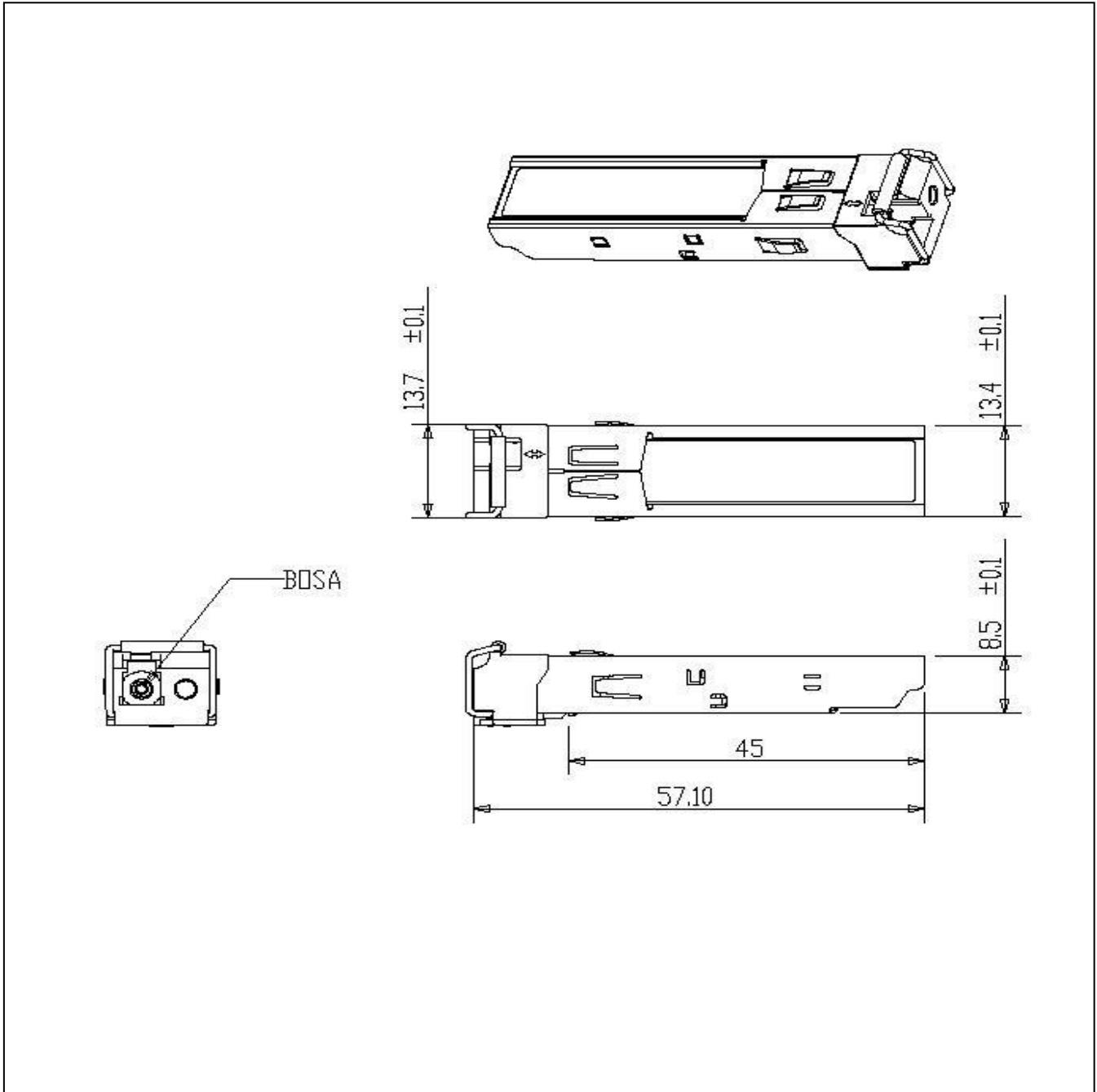

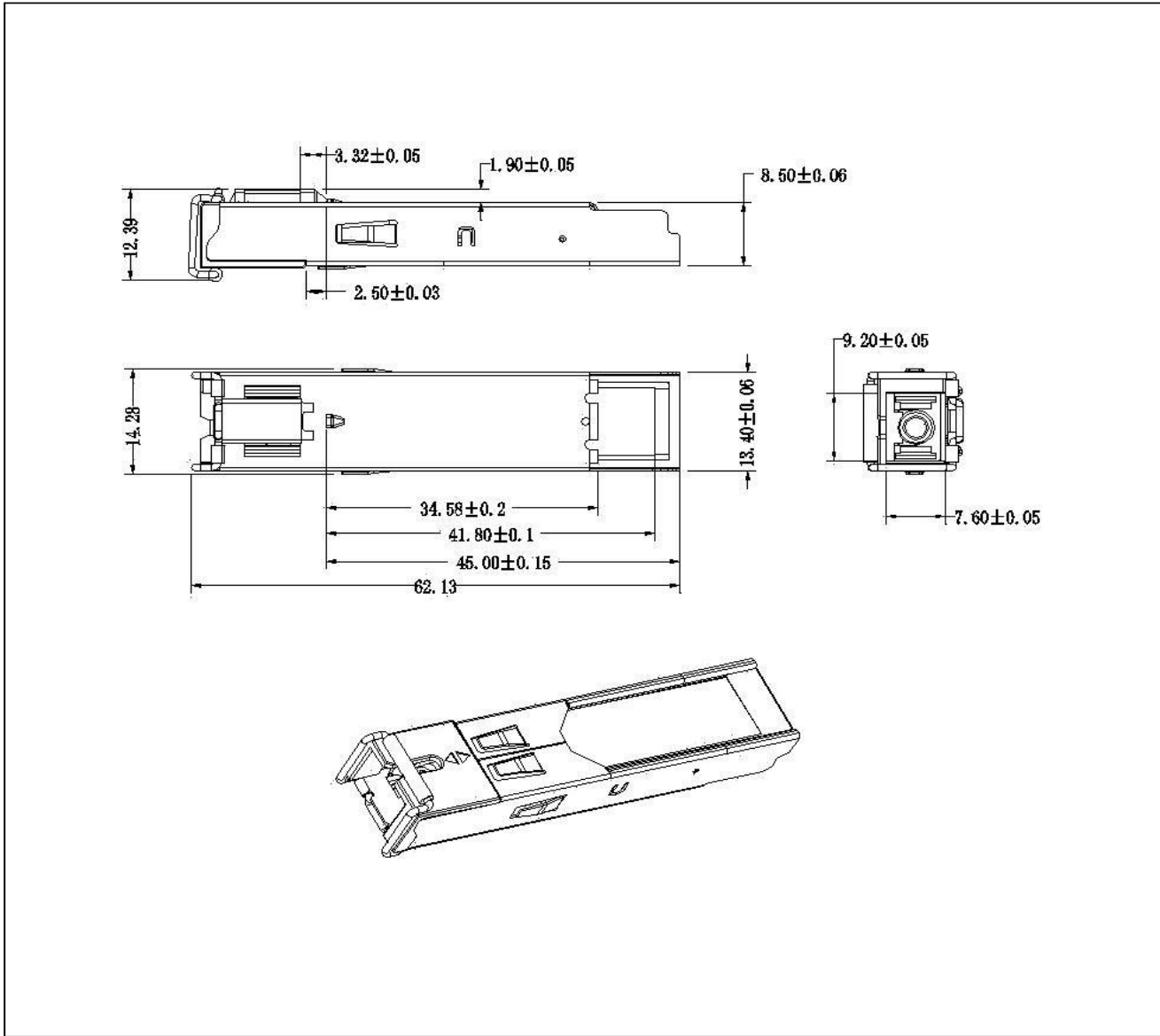

Regulatory Compliance

SFP transceiver is designed to be Class I Laser safety compliant and is certified per the following standards

Feature	Agency	Standard	Certificate / Comments
Laser Safety	FDA	CDRH 21 CFR 1040 and Laser Notice No. 50	1120295-000
Product Safety	BST	EN 60825-1: 2007 EN 60825-2: 2004 EN 60950-1: 2006	BT0905142001
Environmental protection	SGS	RoHS Directive 2002/95/EC	GZ0902007478/CHEM
EMC	CCIC	EN 55022: 2006+A1: 2007 EN 55024: 1998+A1: 2001+A2: 2003	CTE09020023

Ordering information

Part Number	Product Description
NPB-4548L-L8C	1490nm, 2.5Gbps, LC,80km, 0°C~+70°C
NPB-4548L-L8CD	1490nm, 2.5Gbps, LC,80km, 0°C~+70°C, With Digital Diagnostic Monitoring